

Write your name here

Surname

Other names

Centre Number

Candidate Number

Edexcel GCSE

Mathematics B

**Unit 2: Number, Algebra, Geometry 1
(Non-Calculator)**

Higher Tier

Wednesday 13 June 2012 – Morning

Time: 1 hour 15 minutes

Paper Reference

5MB2H/01

You must have: Ruler graduated in centimetres and millimetres, protractor, pair of compasses, pen, HB pencil, eraser. Tracing paper may be used.

Total Marks

Instructions

- Use **black** ink or ball-point pen.
- **Fill in the boxes** at the top of this page with your name, centre number and candidate number.
- Answer **all** questions.
- Answer the questions in the spaces provided – *there may be more space than you need.*
- **Calculators must not be used.**



Information

- The total mark for this paper is 60
- The marks for **each** question are shown in brackets – *use this as a guide as to how much time to spend on each question.*
- Questions labelled with an **asterisk** (*) are ones where the quality of your written communication will be assessed.

Advice

- Read each question carefully before you start to answer it.
- Keep an eye on the time.
- Try to answer every question.
- Check your answers if you have time at the end.

Turn over ►

P40641A

©2012 Pearson Education Ltd.

6/6/7



PEARSON

GCSE Mathematics 2MB01

Formulae: Higher Tier

**You must not write on this formulae page.
Anything you write on this formulae page will gain NO credit.**

Volume of prism = area of cross section \times length

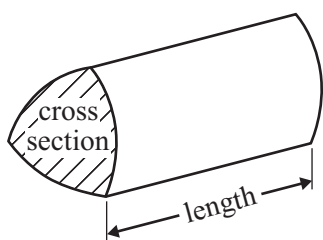

Area of trapezium = $\frac{1}{2}(a + b)h$

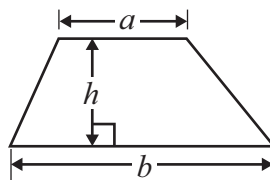

Volume of sphere = $\frac{4}{3}\pi r^3$

Surface area of sphere = $4\pi r^2$

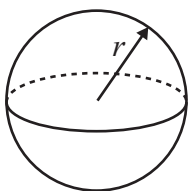

Volume of cone = $\frac{1}{3}\pi r^2 h$

Curved surface area of cone = $\pi r l$

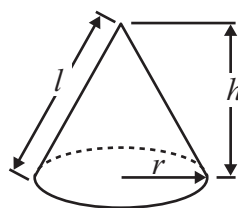

In any triangle ABC

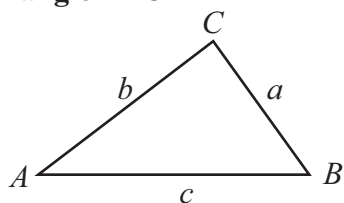

The Quadratic Equation

The solutions of $ax^2 + bx + c = 0$

where $a \neq 0$, are given by

$$x = \frac{-b \pm \sqrt{b^2 - 4ac}}{2a}$$

Sine Rule $\frac{a}{\sin A} = \frac{b}{\sin B} = \frac{c}{\sin C}$

Cosine Rule $a^2 = b^2 + c^2 - 2bc \cos A$

Area of triangle = $\frac{1}{2}ab \sin C$



Answer ALL questions.

Write your answers in the spaces provided.

You must write down all stages in your working.

You must NOT use a calculator.

*1

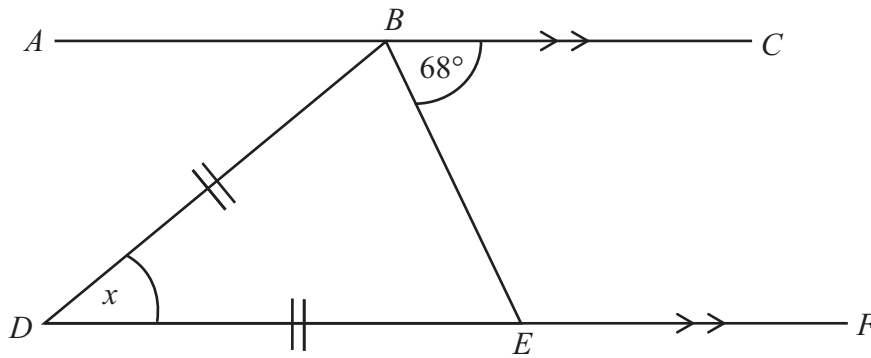

Diagram NOT
accurately drawn

BDE is an isosceles triangle.

$DB = DE$.

The straight line ABC is parallel to the straight line DEF .

Work out the size of the angle marked x .

You must give reasons for each stage in your working.

(Total for Question 1 is 4 marks)



2 Here are the first four terms of a number sequence.

6 10 14 18

Write an expression, in terms of n , for the n th term of this sequence.

.....

(Total for Question 2 is 2 marks)

3 Graham and Michael share £35 in the ratio 5 : 2

Work out the amount of money that Graham gets.

£

(Total for Question 3 is 2 marks)

4 Work out $\frac{2}{5} + \frac{3}{8}$

Give your answer in its simplest form.

.....

(Total for Question 4 is 2 marks)



- 5 A TV costs £400
Peter pays a deposit of 15%.

How much does Peter still have to pay for the TV?



£

(Total for Question 5 is 3 marks)

- 6 (a) Factorise $10a + 5$

.....
(1)

- (b) Expand and simplify $5(x + 7) + 3(x - 2)$

.....
(2)

- (c) Factorise completely $3a^2b + 6ab^2$

.....
(2)

(Total for Question 6 is 5 marks)



7 Here is part of Jo's electricity bill.

Electricity Bill		May 2012
J. Evans 3 Hillside Ave London		
2012		CP Energy Connecting people Connecting places
Reading 1st Jan	02792 units	
Reading 1st April	03307 units	
Number of units used	515 units	
Cost: 35p per unit		

Work out how much Jo has to pay for the units she has used.

£

(Total for Question 7 is 4 marks)



8 The diagram shows a triangular prism.

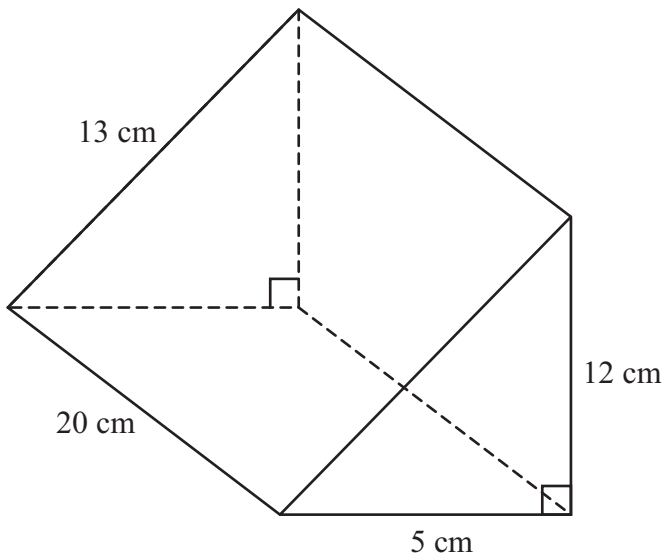

Diagram **NOT** accurately drawn

Work out the total surface area of the prism.

..... cm²

(Total for Question 8 is 3 marks)



9 On the grid, draw the graph of $y = 2x - 3$ for values of x from -2 to 2

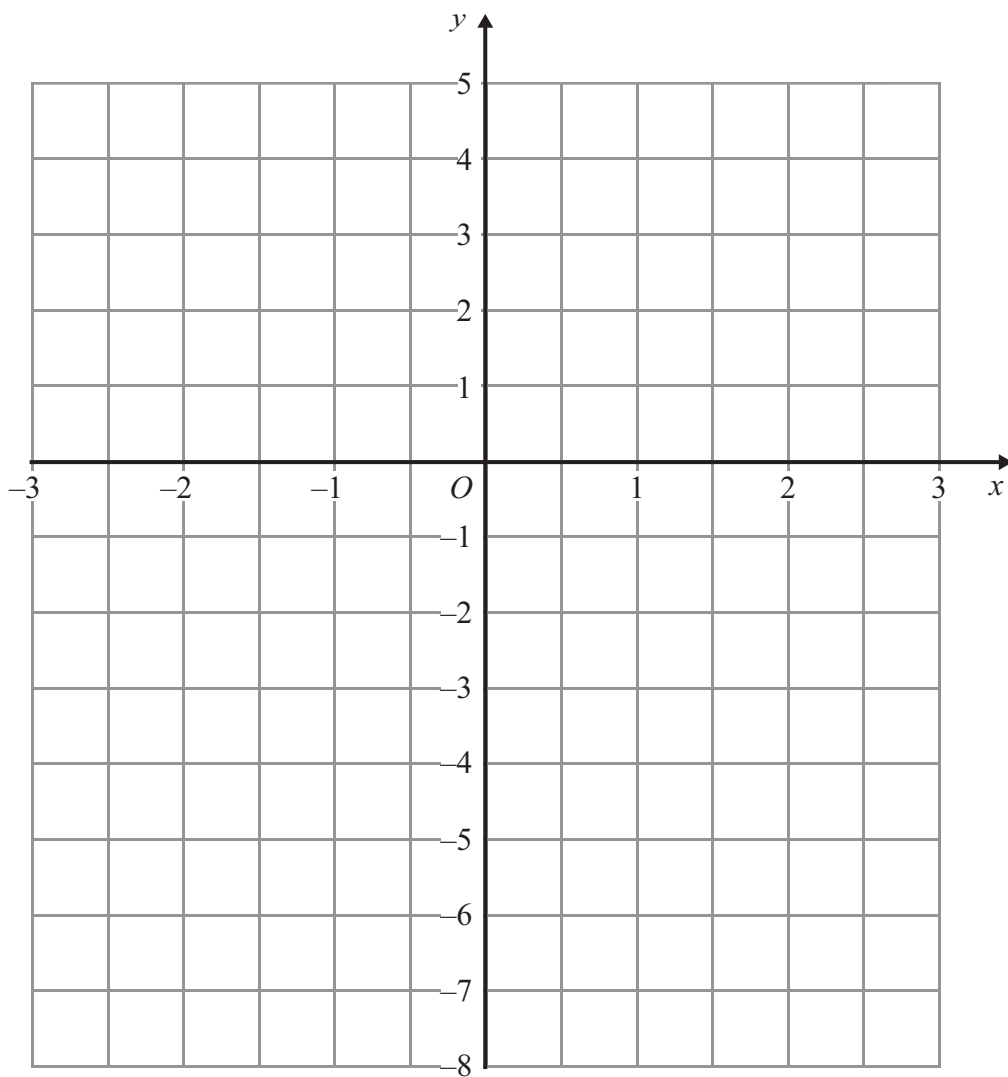

(Total for Question 9 is 3 marks)



- 10 Janice cuts a triangle from a rectangular piece of metal. She uses the rest of the metal to make a name badge.

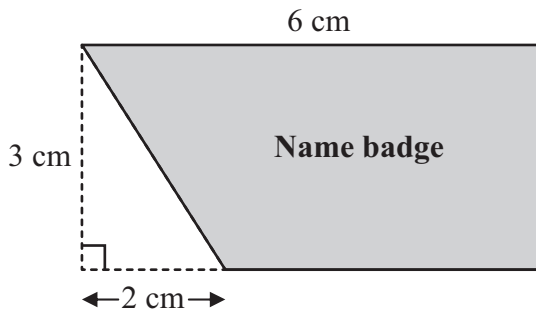

Diagram **NOT** accurately drawn

The rectangle has length 6 cm and width 3 cm.
The right-angled triangle has base 2 cm and height 3 cm.

Work out the area of the name badge.

.....
(Total for Question 10 is 4 marks)



11 Danny bought a car for £10 000

The value of the car depreciated by 20% in the first year.
Then the value of the car depreciated by 10% in the second year.

Work out the value of Danny's car at the end of two years.

£.....

(Total for Question 11 is 3 marks)

12 (a) Expand and simplify $(x + 5)(x - 8)$

.....
(2)

(b) Factorise $x^2 - 16$

.....
(1)

(Total for Question 12 is 3 marks)



13 The diagram shows a cuboid drawn on a 3-D coordinate grid.

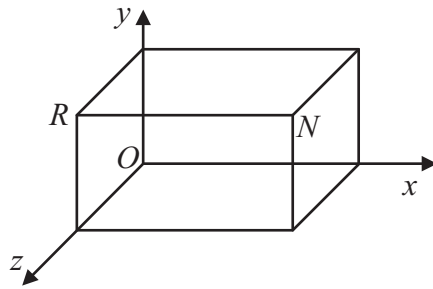

Diagram **NOT** accurately drawn

The vertex N of the cuboid has coordinates $(6, 2, 4)$.

(a) What are the coordinates of the vertex R ?

(..... , ,)
(1)

(b) What are the coordinates of the midpoint of the line segment RN ?

(..... , ,)
(2)

(Total for Question 13 is 3 marks)

14 (a) Write the recurring decimal $0.2\dot{5}$ as a fraction in its simplest form.

.....
(3)

(b) Rationalise the denominator of $\frac{12}{\sqrt{6}}$

Give your answer in its simplest form.

.....
(2)

(Total for Question 14 is 5 marks)



*15

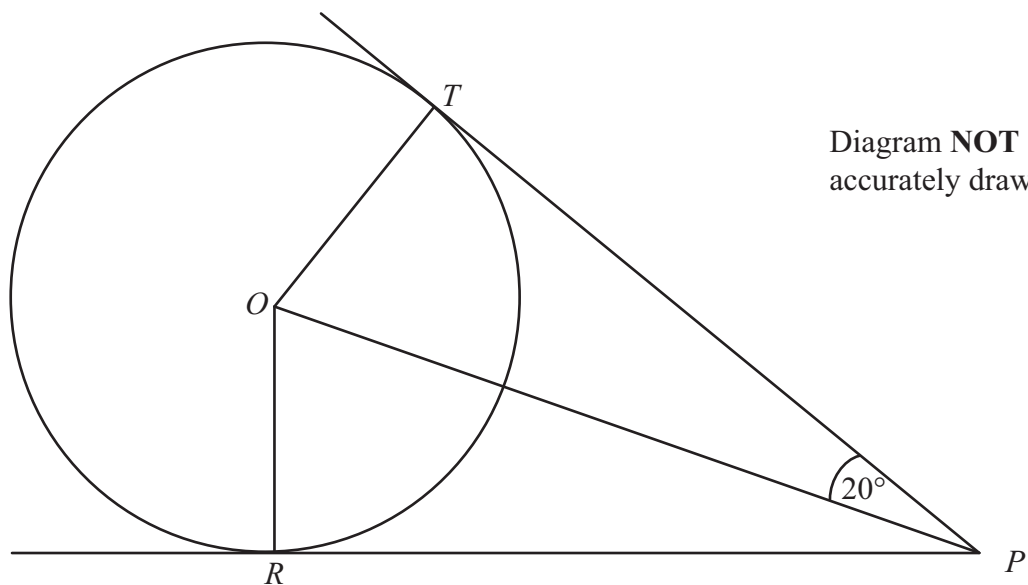

Diagram **NOT**
accurately drawn

T and R are two points on a circle centre O .

PT and PR are the tangents to the circle from P .

Angle $TPO = 20^\circ$.

Work out the size of angle TOR .

You must give reasons for each stage of your working.

(Total for Question 15 is 4 marks)



16 Judy drives at an average speed of 80 km per hour for 2 hours 45 minutes.

Work out the number of **miles** Judy drives.

..... miles

(Total for Question 16 is 3 marks)

17 Find an equation of the straight line that is perpendicular to the straight line $x + 2y = 5$ and that passes through the point (3, 7).

.....

(Total for Question 17 is 4 marks)



18 Simplify completely $\frac{2x^2 - 9x - 5}{4x^3 + 2x^2}$

.....
(Total for Question 18 is 3 marks)

TOTAL FOR PAPER IS 60 MARKS



BLANK PAGE



BLANK PAGE

